

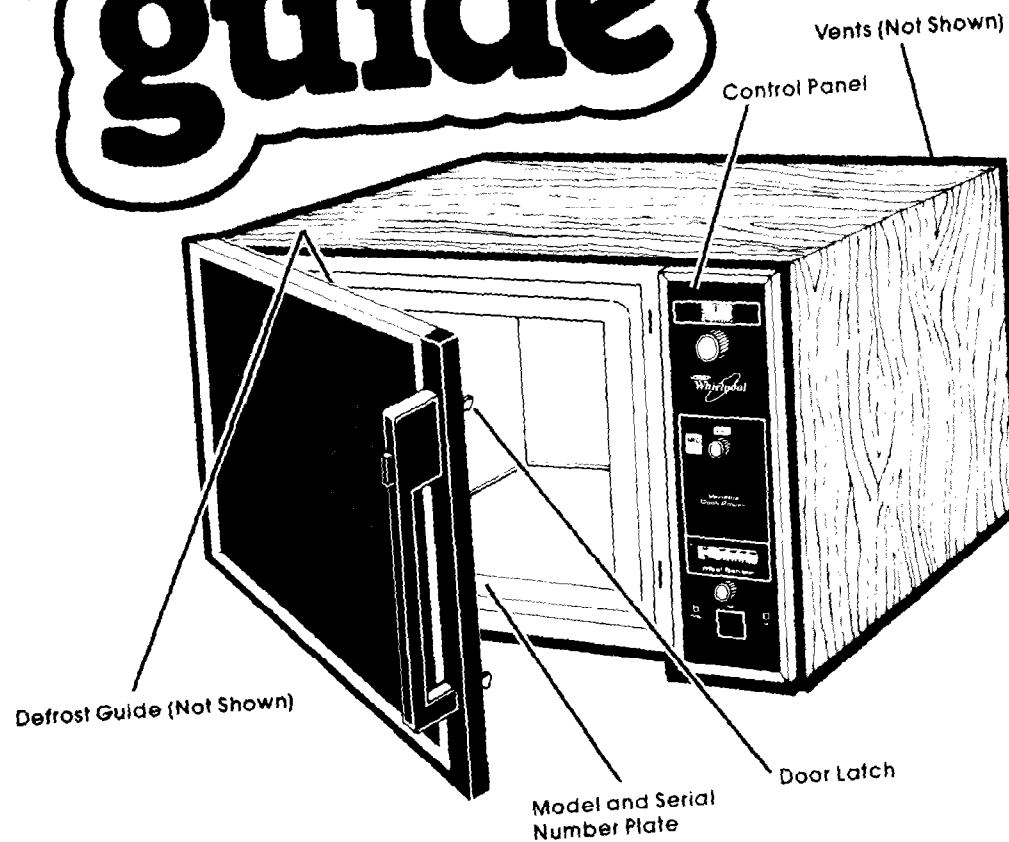

Microwave Oven Model MW8300XL

# use & care guide



## Copy Your Model and Serial Numbers Here

If you need service or call with a question, have this information ready.

1. Complete Model and Serial Numbers (from the plate just behind the microwave oven door on the oven frame).
2. Purchase date from sales slip (or date installed).

Copy this information in these spaces. Keep this book, your warranty and sales slip together in a handy place.

Model Number

Serial Number

Purchase Installation Date

Service Company and Phone Number

# Contents

	Page		Page
<b>Responsibilities</b> .....	2	Cooking with the Temperature	
Installation .....	2	Probe .....	6
Proper, Safe Use .....	3	Important Information .....	8
Precautions to Avoid Possible		How Microwave Ovens Work .....	10
Exposure to Excessive		Replacing the Light Bulb .....	10
Microwave Energy .....	3	<b>Building In Your Microwave Oven</b> ...	11
<b>Using Your Microwave Oven</b> .....	4	<b>If You Need Service or Assistance</b> ...	11
Setting the Controls .....	4	1. Before Calling For Assistance ...	11
Defrosting .....	5	2. If You Need Assistance .....	12
Cleaning the Microwave Oven ...	5	3. If You Need Service .....	12
		4. If You Have a Problem .....	12

## Your responsibilities...

Fill out and return the "Microwave Registration Card" attached to the oven door.

## Installation

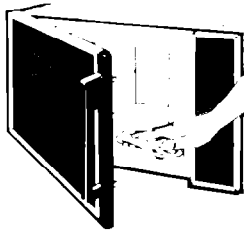

**1.** Empty the microwave oven and clean inside it with a soft, damp cloth

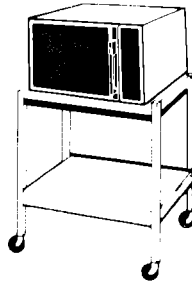

**2.** Put the oven on a cart, counter, table or shelf that is strong enough to hold the oven. **(The control side of the unit is the heavy side. Handling can be tricky.)**

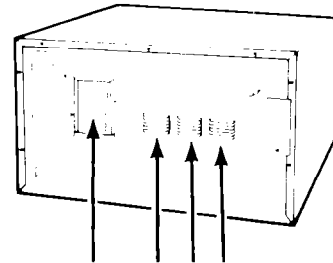

**3. Do not block vents on back of the oven.** Blocking vents can cause poor cooking results.

**4.** For your safety, **this oven must be grounded.** DO NOT REMOVE THE THIRD PRONG FROM THE PLUG. You must have a qualified electrician put in the right outlet if yours does not have the 3-prong plug-in, or if the outlet is not grounded according to National Electrical Codes and local codes or ordinances. The outlet must supply 120 volts, 60 Hz A.C. When the oven is on, it will use about 1375 watts. It should not share a circuit with another appliance.

**5.** Put about one cup (250 mL) of cold water in a glass container in the oven. Close the door. Make sure it locks. Follow the directions on page 4 to set the oven to COOK for 1 1/2 minutes. When the time is up, the water should be heated.

**6. Fill out and return the "Microwave Registration Card" attached to the oven door.** If the card is missing, please send the model and serial number of your microwave oven, with your name and address to...

Whirlpool Corporation  
Microwave Registration Department  
Administrative Center  
2000 U.S. 33 North  
Benton Harbor, Michigan 49022

This information will help us reach you if there is ever a need to pass along information about your microwave oven.

# Proper, safe use

## Your microwave must be...

- Installed according to the installation instructions
- Protected from the weather.
- Used only for jobs expected of home microwave ovens.
- Used only by people who can operate it properly.
- Kept clean and in good repair.

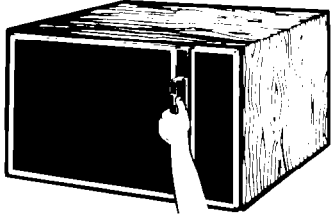

**NEVER** start the oven when it's empty. The oven can be damaged.



**DO NOT** cook or reheat whole eggs in the microwave oven. Steam build-up can cause an egg to burst. Damage to the oven or injury to the user may result.



**DO NOT** use the oven until you have read and understand **ALL** the information on safe use.

## PRECAUTIONS TO AVOID POSSIBLE EXPOSURE TO EXCESSIVE MICROWAVE ENERGY...

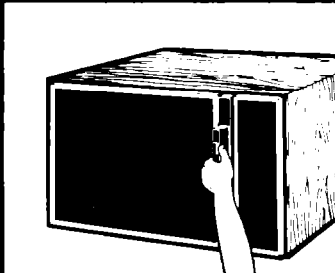

**DO NOT** attempt to operate this oven with the door open since open-door operation can result in harmful exposure to microwave energy. It is important not to defeat or tamper with the safety interlocks.

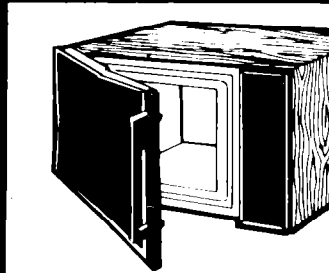

**DO NOT** operate the oven if it is damaged. It is particularly important that the oven door close properly and that there is no damage to the  
(1) Door (bent),  
(2) Hinges and latches (broken or loosened),  
(3) Door seals and sealing surfaces.

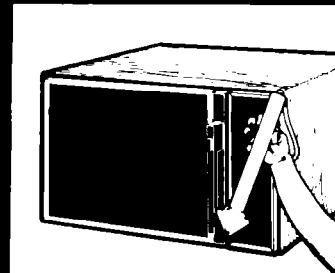

The microwave oven should be checked for microwave leakage by qualified service personnel after a repair is made.

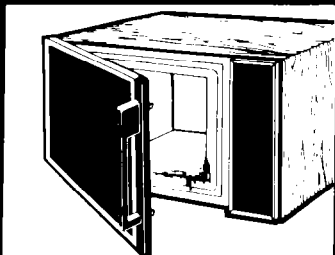

**DO NOT** place any object between the oven front face and the door or allow soil or cleaner residue to accumulate on sealing surfaces.

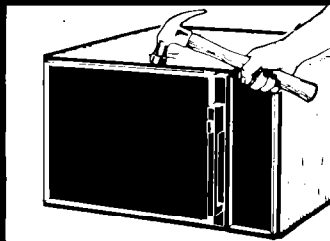

The oven should not be adjusted or repaired by anyone except properly qualified service personnel.

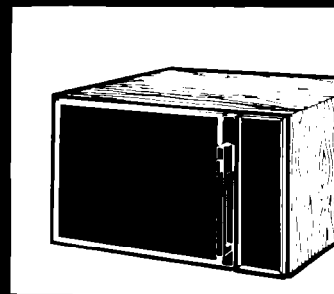

**DO NOT** operate the microwave oven if the door glass is broken.

**DO NOT** operate the microwave oven with the outer cabinet removed.

# Using your microwave oven

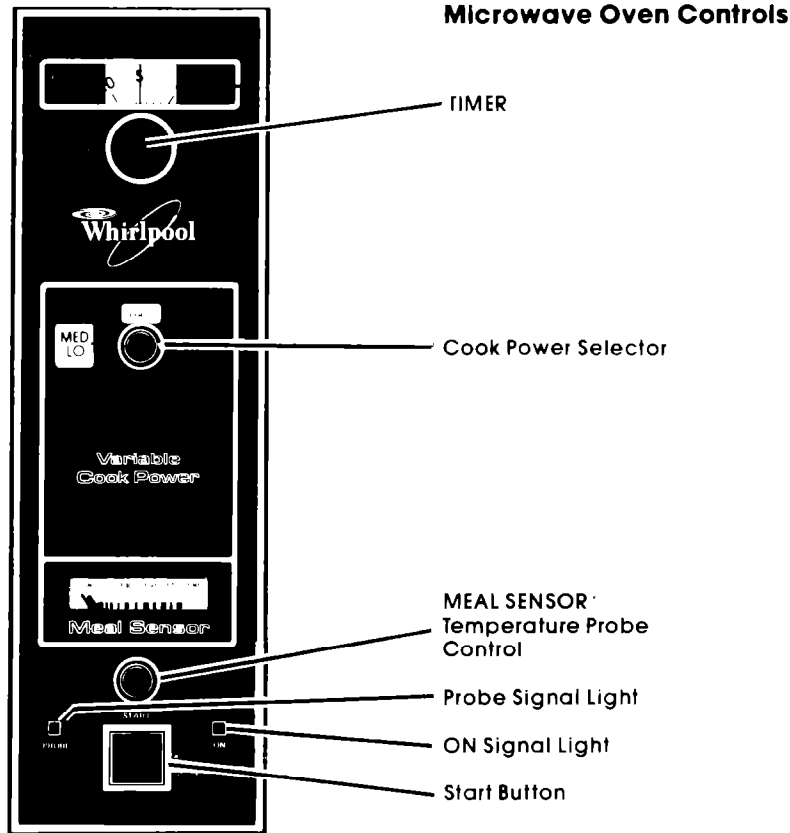

## SETTING THE CONTROLS

Be sure you understand the basics of microwave oven cooking before you start. Start with recipes from your MICRO MENUS Cookbook. Follow the directions carefully.

**NEVER START THE OVEN WHEN IT'S EMPTY.** The oven can be damaged. For testing, use at least a cup of water.

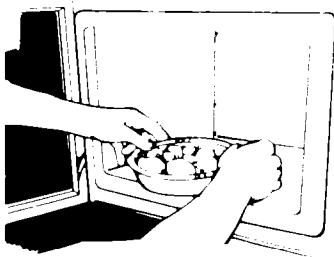

**Be sure you have read and understand the directions.**

1. Put food in the oven

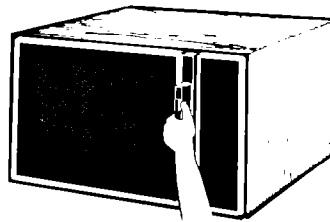

2. Close the door. Make sure it locks. The oven won't work if the door isn't closed tightly.
3. Set cooking times up to 35 minutes by turning the timer knob clockwise. The oven light will come on. Turn counterclock-

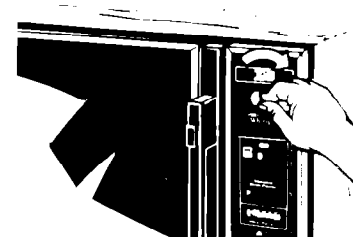

wise to reduce time.  
**Each mark is 15 seconds for the first 5 minutes. After 5 minutes, each mark is 1 minute.**

To set time for less than 1 minute, turn timer past 1 minute then to desired time.

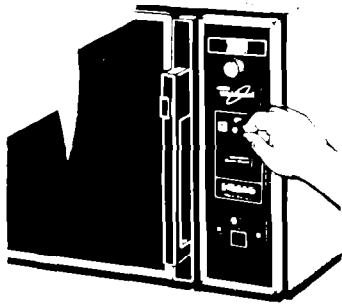

4. Set Cook Power to desired setting from HI to LO. Some recipes require different Cook Powers for best results. (See chart.) The lower the Cook Power the slower the cooking.

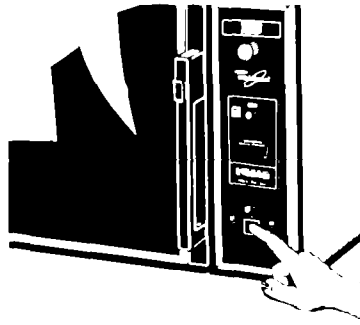

5. Push the START Button. The oven light will stay on. You will hear a fan running during oven operation.

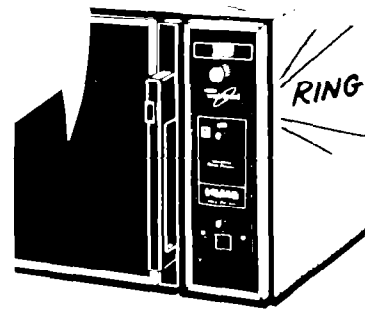

6. When the set time is up the oven will shut off automatically. You will hear a bell, the light will go off and the fan will stop.

#### COOK POWER CHART

Recipes in the MICRO MENUS Cookbook use Cook Power settings from HI to LO. Recipes in other books and magazines may use different percentages of cooking power. The following chart will be helpful:

HI	– 100% of full power
MED-HI	– 70% of full power
MED	– 50% of full power
MED-LO	– 30% of full power
(DEFROST)	
LO	– 15% of full power

#### TO STOP THE OVEN

1. Turn the timer knob counterclockwise to 0.  
OR
2. Open the oven door.

#### TO RESTART THE OVEN

1. Close the oven door.
2. Set timer (if needed). To set timer for less than 1 minute, turn timer past 1 minute then to desired time.
3. Push the START Button.

#### DEFROSTING

For defrosting, set Cook Power Control to DEFROST (MED-LO) setting. See the Defrost Guide inside the oven door or your MICRO MENUS Cookbook for suggested defrost times.

1mk

## CLEANING THE MICROWAVE OVEN



Wipe often with warm sudsy water and a soft cloth or sponge.

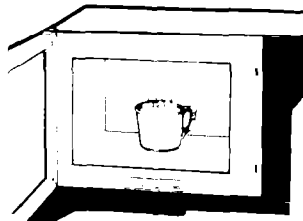

For stubborn soil, boil a cup of water in the oven for 2 or 3 minutes. Steam will soften the soil.

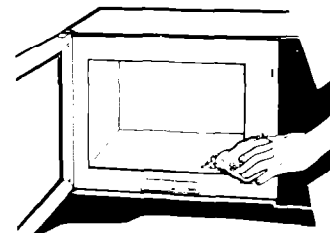

Be sure to clean the areas where the door and oven frame touch when closed. Rinse well.

**Do not use abrasive cleaners or steel wool pads.**

## THE MEAL SENSOR \* TEMPERATURE PROBE

Roast or bake meats or casseroles to a set temperature instead of by time. When the MEAL SENSOR Temperature Probe is properly used, the microwave oven will turn off automatically when the probe senses the temperature you set.

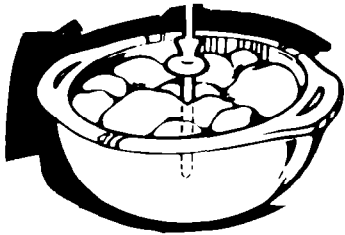

For casseroles, the tip of the probe should be in the center of the food. Stir foods when recommended. Replace the probe.

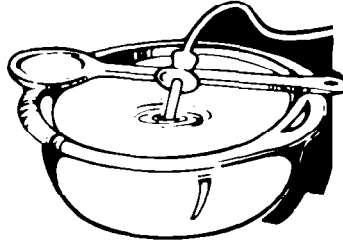

For liquids, balance the probe on a wooden spoon or spatula so the tip of the probe is in the center of the liquid.

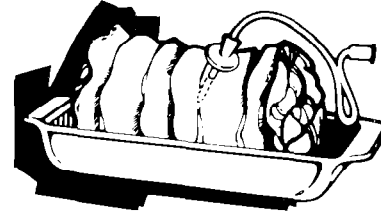

For roasts, the tip of the probe should be in the center of the largest muscle, but not touching fat or bone.

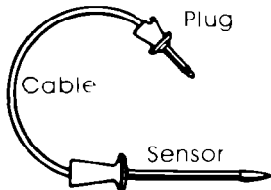

1. Insert at least 1/2 of the temperature probe into the food.

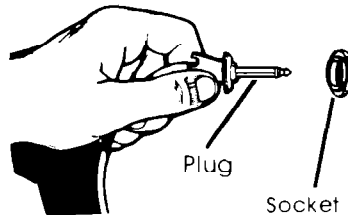

2. Place food in the oven and plug the probe into the socket on the oven wall.

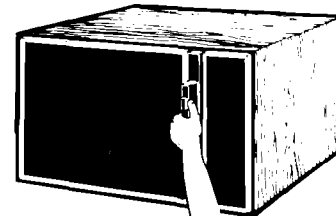

3. **Make sure the probe does not touch any part of the oven interior.** Close the door. The Probe Signal Light will come on.

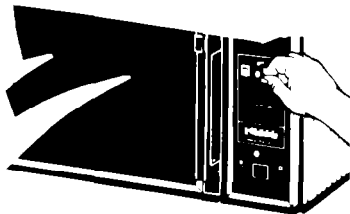

4. Set the Cook Power if desired.

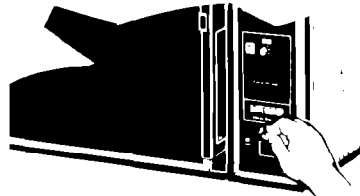

5. Move the Meal Sensor pointer to the final cooking temperature you want.

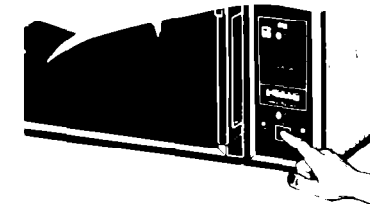

6. Push the START Button. When the probe senses the cooking temperature, a buzzer sounds, and the oven turns off.

### DO...

- use hot pads when removing probe from food or food from oven.
- stir foods during cooking when recommended.
- stir soups, casseroles and drinks before serving.
- cover roasts with foil and let stand a few minutes after cooking. Remove foil if you decide to cook it longer.

### DON'T...

- let probe or probe cable touch any part of the oven interior.
- let probe touch foil (if used). Foil can be kept away from probe with wooden toothpicks. Remove foil if arcing occurs.
- use paper, plastic wrap or plastic containers. They will be in the oven too long.
- use probe in regular oven.
- force probe into frozen food.
- use probe for foods that need to simmer.

## MEAL SENSOR TEMPERATURE PROBE GUIDE

Food	Cook Power Setting	Meal Sensor Setting	Tips
Beverages	<b>HIGH</b>	165 F to 170 F	Balance probe on wooden spoon
Canned Food	<b>HIGH</b>	170 F	Use <b>MEDIUM</b> Cook Power for very thick foods such as baked beans
Casseroles	<b>MEDIUM HIGH</b>	170 F to 175 F	Use <b>MEDIUM</b> Cook Power for very thick mixtures. Stir once or twice.
Chowders	<b>MEDIUM HIGH</b>	180 F	Balance probe on wooden spoon. Stir once or twice
Dips	<b>MEDIUM</b>	140 F	
Meat Loaf (beef)	<b>MEDIUM HIGH</b>	170 F	
Poultry	Do not use the MEAL SENSOR probe when cooking poultry. Because of the amount of bone and shape of poultry, there is no place where the meat is thick enough to place the probe properly.		
Sandwiches	<b>MEDIUM</b>	110 F	Place sandwich on paper napkin. Insert probe from side so tip is in center of filling. Thick sandwiches work best.
Soup	<b>HIGH</b>	165 F to 170 F	Balance probe on wooden spoon. Stir once or twice

### TIPS

- Casseroles cooked using the MEAL SENSOR probe should be made from precooked foods. Do not use raw meats, raw vegetables and cream sauces in casseroles
- Dry casseroles do not work well
- Thaw frozen casseroles and meats in the microwave oven before inserting the probe.
- If you are cooking individual servings such as mugs of soup, check the probe setting
- in several of the items – all the mugs may not heat at the same rate.
- Dry meat loaf mixtures don't work well.
- Remember that roasts may vary in size, shape and composition. Use the timings for minutes per pound as a guideline as well as the MEAL SENSOR probe.
- Starchy vegetables tend to stick to the MEAL SENSOR probe.

### CLEANING THE PROBE:

1. Remove probe from microwave oven using hot pads.
2. Wipe probe with a hot sudsy cloth. Use a plastic scouring pad to remove stubborn foods
3. Probe may be placed in silverware basket of dishwasher
4. **Be careful** not to kink the cable.

**NOTE:** Make sure you have the right probe for your oven. It will have "LO-Z" on the handle

## IMPORTANT INFORMATION

Before you start using your microwave oven, read this section carefully. *This information will help you avoid damage to your oven.*

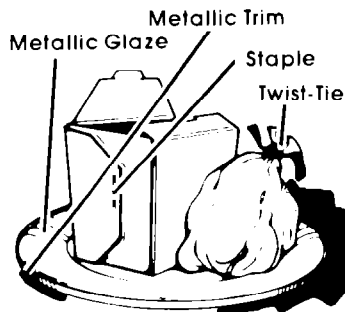

Cooking in metal containers **can damage the oven**. So can containers with **hidden metal** (twist-ties, foil-lining, staples, metallic glaze or trim). *Test dinnerware or cookware before using.*

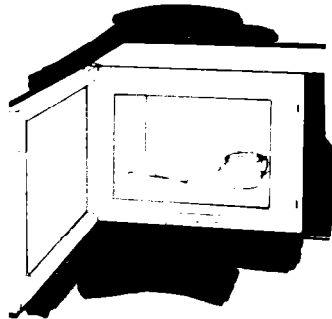

*To test a dish for safe use, put it into the oven with a cup of water **beside** it. Cook on high Cook Power for one minute. **If the dish gets hot and the water stays cool, do not use it.***



**NEVER COOK OR REHEAT A WHOLE EGG.** Slice hard boiled eggs before heating. Steam build-up in whole eggs may cause them to burst and possibly damage the oven.

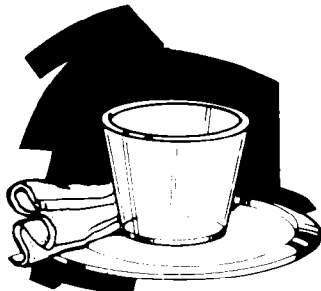

Paper can char or burn, and some plastics can melt if used when heating foods for more than 4 minutes.

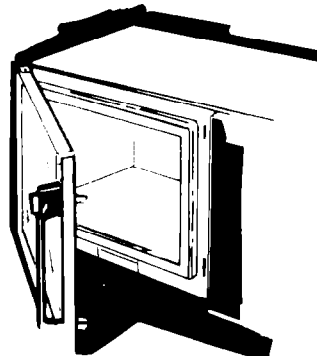

**NEVER** start a microwave oven when it's empty. The oven can be damaged. If you experiment, put a container of water in the oven.

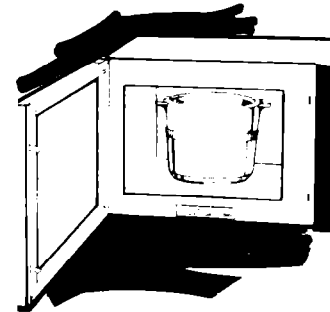

Don't let anything touch the top of the oven cavity.





Rough or harsh cleaners can scratch or dull the oven finish. **DO NOT USE THEM.**

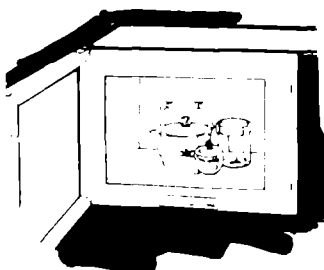

**DO NOT** store things in the oven.



Overcooking some foods can cause them to scorch or flame...especially foods like potatoes, popcorn, snacks, etc. See the MICRO MENUS<sup>®</sup> Cookbook.

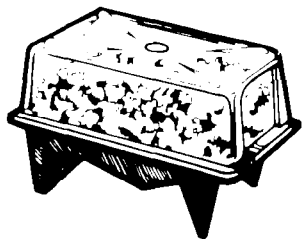

Make popcorn only in poppers designed for use in microwave ovens. Follow popper directions. Results are the popper manufacturer's responsibility.

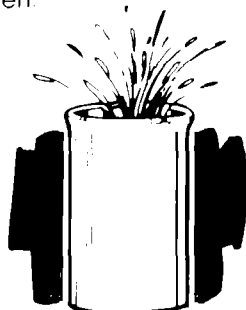

Liquids heated in certain containers may overheat. The liquid may then splash out with a loud noise. This does not harm the oven, but you should not use such containers to heat liquids again.



**DO NOT OVERCOOK POTATOES.** At the end of the recommended cooking time they should be slightly firm. Wrap in foil and set aside for 5 minutes. They will finish cooking while standing.

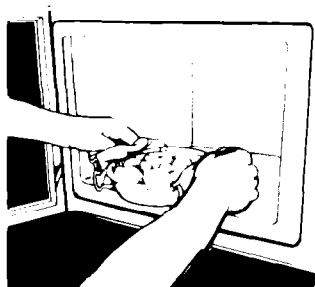

**USE HOT PADS.** Microwave energy does not heat containers, but the hot food does.



Follow MICRO MENUS<sup>®</sup> Cookbook directions carefully. If using a different cookbook, you may need to experiment with times and Cook Powers.

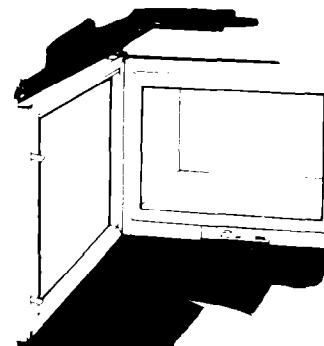

It is normal for the inside of the oven door to look wavy after the oven has been running for a while.



If your electric power line voltage is less than the normal 120 volts, cooking times may be longer.

- Double-check all settings.
- Use the oven only for defrosting, cooking or reheating.

It is normal for the signal lights to flicker while the microwave oven is on.

## HOW MICROWAVE OVENS WORK

Microwave ovens are safe. Microwave energy is not hot. It causes food to make its own heat and it's this heat that cooks the food.

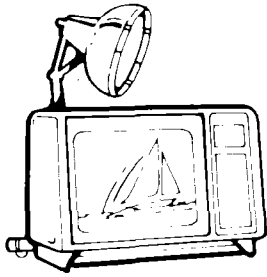

Microwaves are like TV waves or light waves. You can't see them, but you can see what they do.

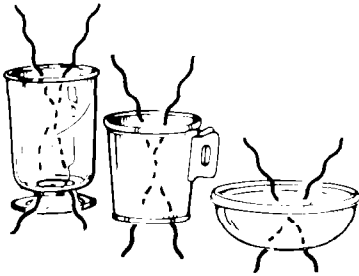

Microwaves pass through glass, paper and plastic without heating them so food absorbs the energy. Microwaves bounce off metal pans so food does not absorb the energy.

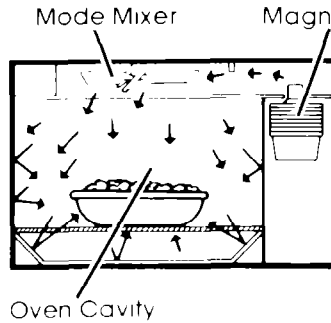

Oven Cavity

A magnetron in the microwave oven produces microwaves. The microwaves move into the oven where they are scattered or stirred by a mode mixer (like a fan). Microwaves bounce off metal oven walls and are absorbed by food.



Microwaves may not reach the center of a roast. The heat around the outside is what cooks the roast all the way through. This is one of the reasons for letting some foods (roasts, baked potatoes) stand for a while after cooking, or for stirring some foods during the cooking time.

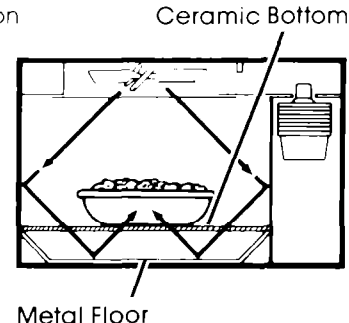

Metal Floor

The ceramic bottom of your microwave oven lets microwaves through. Then they bounce off a metal floor, back through the ceramic bottom and are absorbed by the food.



The microwaves disturb water molecules in the food. As the molecules bounce around bumping into each other, heat is made, like rubbing your hands together. This is the heat that cooks.

## REPLACING THE LIGHT BULB

1. Unplug the power cord.
2. Remove holding screw on access panel.
3. Remove the light bulb from its socket.
4. Replace bulb with a 40-watt **appliance** bulb.
5. Replace the access panel and holding screw.
6. Plug in the power cord.

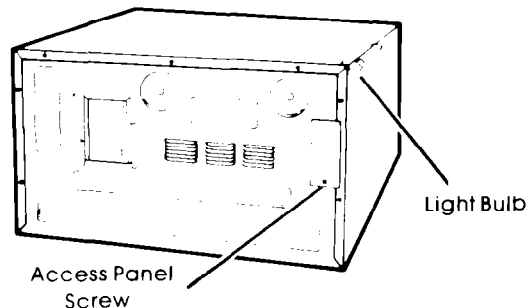

# Building in your microwave oven

Your microwave oven is not limited to carts, counters or tables. Custom installations are made easy with kits available from your dealer.

- 1.** Build the microwave oven into a cabinet or wall by itself or over built-in single ovens in the Whirlpool RDE, REE, RGE, RB and SB model series or Imperial 7200 single gas ovens.
- 2.** Attach the microwave oven to a wall by itself or with cabinets over it.
- 3.** Put the microwave oven on the MICRO SHELF™ Hood over a cooktop. The hood is available ducted or as a recirculating hood, and includes cooktop lights.

Ask your dealer for details on .

- RCK803 (832849) – 30-inch Built-in Kit
- RCK805 (832856) – 25 1/4-inch Built-in Kit
- RCK807 (832850) – 27-inch Built-in Kit
- RCK710 (832763) – Wall Mount Kit
- RCK811 (832875) – Wall Mount Vent Grille and Filler Kit
- RCK713 (832769) – Wall Mount Cookbook Storage Cabinet
- RH3330XL – MICRO SHELF Hood

## If you need service or assistance, we suggest you follow these four steps:

### 1. Before calling for assistance...

Performance problems often result from little things you can find and fix yourself without tools of any kind.

#### If nothing operates:

- Is the oven correctly plugged into a live circuit with the proper voltage? (See page 2.)
- Have you checked the main fuse or circuit breaker box?

#### If the microwave oven will not run:

- Is the timer set?
- Is the door firmly closed and latched?
- Did you push the START Button?
- Did you follow the directions on pages 4 and 5 **exactly**?

#### If microwave cooking times seem too long:

- Is the electric supply to your home low or lower than normal? Your electric company can tell you if the line voltage is low.
- Is the Cook Power at the recommended setting?
- Are you allowing for more time when cooking more food at one time?

#### If the microwave oven turns off too soon or not soon enough when using the probe:

- Is at least 1/3 of the probe in the food?
- Is the probe tip in the center of the food?
- Is the probe touching bone or fat?
- Have you allowed roasts to stand for a few minutes after cooking?
- Is the probe plugged tightly into its socket?
- Is the Cook Power set where it should be?
- Is the MEAL SENSOR™ Probe Control set at the end temperature you want?
- Do you have the correct probe for your oven? See page 7.

## 2. If you need assistance\* ...

Call the Whirlpool COOL-LINE<sup>®</sup> service assistance telephone number. Dial free from:  
Continental U.S. .... (800) 253-1301  
Michigan ..... (800) 632-2243  
Alaska & Hawaii ..... (800) 253-1121

and talk with one of our trained Consultants. The Consultant can instruct you in how to obtain satisfactory operation from your appliance or, if service is necessary, recommend a qualified service company in your area.

## 3. If you need service\*\* ...



Whirlpool has a nationwide network of franchised TECH-CARE<sup>®</sup> Service Companies. TECH-CARE service technicians are trained to fulfill the product warranty and provide after-warranty service, anywhere in the United States. To locate TECH-CARE service in your area, call our COOL-LINE service assistance telephone number (see Step 2) or look in your telephone directory Yellow Pages under:

### APPLIANCES—HOUSEHOLD— MAJOR—SERVICE & REPAIR

WHIRLPOOL APPLIANCES  
FRANCHISED TECH-CARE SERVICE

SERVICE COMPANIES  
XYZ SERVICE CO.  
123 Maple 999-9999

### ELECTRICAL APPLIANCES— MAJOR—REPAIRING & PARTS

OR WHIRLPOOL APPLIANCES  
FRANCHISED TECH-CARE SERVICE

SERVICE COMPANIES  
XYZ SERVICE CO.  
123 Maple 999-9999

### OR

### WASHING MACHINES, DRYERS & IRONERS—SERVICING

WHIRLPOOL APPLIANCES  
FRANCHISED TECH-CARE SERVICE

SERVICE COMPANIES  
XYZ SERVICE CO.  
123 Maple 999-9999



## 4. If you have a problem\*\* ...

Call our COOL-LINE service assistance telephone number (see Step 2) and talk with one of our Consultants, or if you prefer, write to:

Mr. Guy Turner, Vice President  
Whirlpool Corporation  
Administrative Center  
2000 US-33 North  
Benton Harbor, MI 49022

If you must call or write, please provide: model number, serial number, date of purchase, and a complete description of the problem. This information is needed in order to better respond to your request for assistance.



FSP is a registered trademark of Whirlpool Corporation for quality parts. Look for this symbol of quality whenever you need a replacement part for your Whirlpool appliance.

FSP replacement parts will fit right and work right, because they are made to the same exacting specifications used to build every new Whirlpool appliance.



Benton Harbor, Michigan. Automatic Washers, Clothes Dryers, Freezers, Refrigerator-Freezers, Ice Makers, Dishwashers, Built-in Ovens and Surface Units, Ranges, Microwave Ovens, Compactors, Room Air Conditioners, Dehumidifiers, Central Heating and Air Conditioning Systems.